

RoHS Compliant HF

REV.	ECN.NO.	MODIFY.CONTENT
A		NEW
B	N23060601	CHANGE LATCH AND FIXED

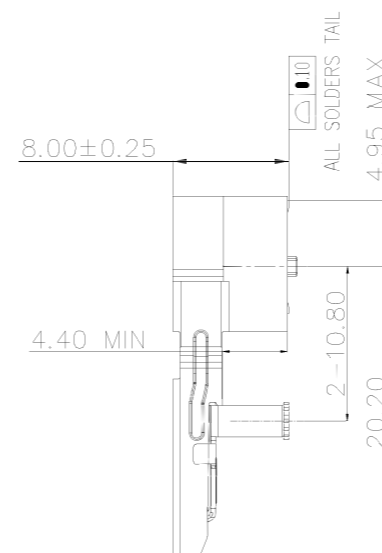
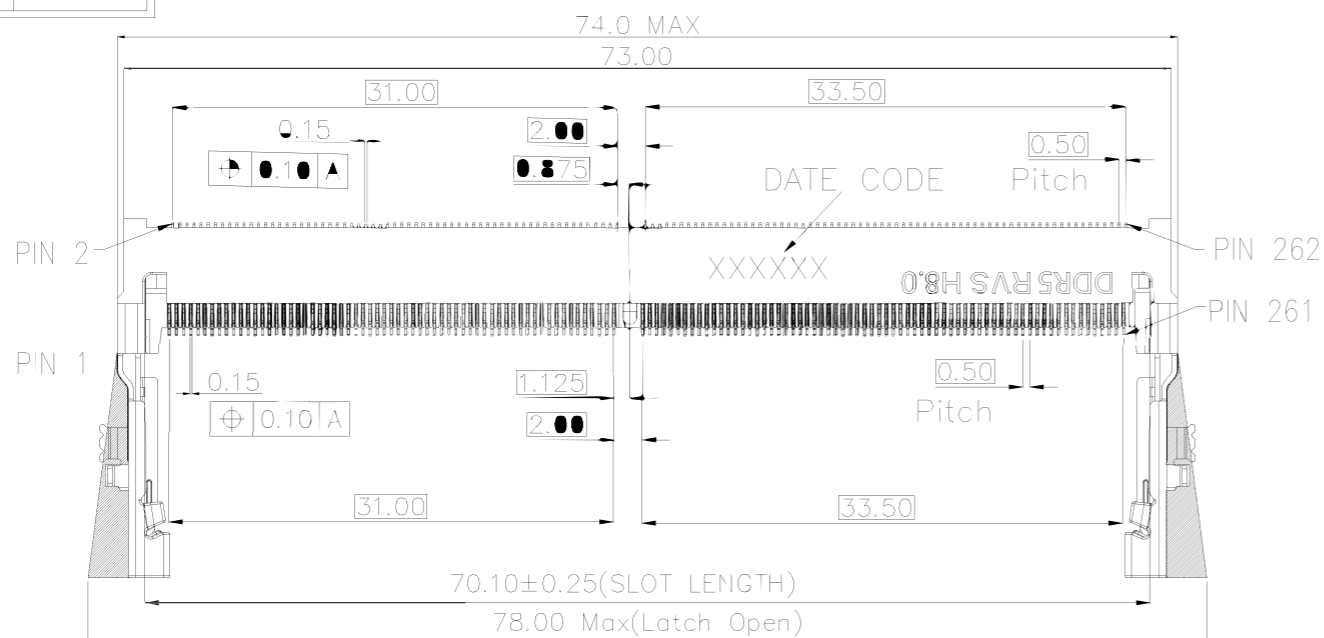

NOTES:  
 1.FINISH:  
 1.1 CONTACT:50u" MIN NICKEL UNDERPLATED ALL OVER.  
 GOLD FALSH PLATING ON SOLDER PAIL.  
 GOLD PLATING (THICKNESS SEE P/N)NO CONTACT AREA.  
 1.2 SOLDER PEG:  
 50u"MIN NICKEL UNDERPLATED ALL OVER.  
 100u"MIN MATTE TIN PLATING ENTIRE OVER.  
 2.DATE CODE:YYWDLX.  
 YY:YEAR(20:2020)  
 MM:MONTH(01:JANUARY)  
 DD:DAY(1~31)  
 3.RECOMMENDED STENCIL THICKNESS:0.12mm MIN

PART.NO.:  
 DDR006-S5401-\*\*

- 08: 1U"
- 09: 3U"
- 10: 5U"
- 11: 10U"
- 12: 15U"
- 13: 30U"

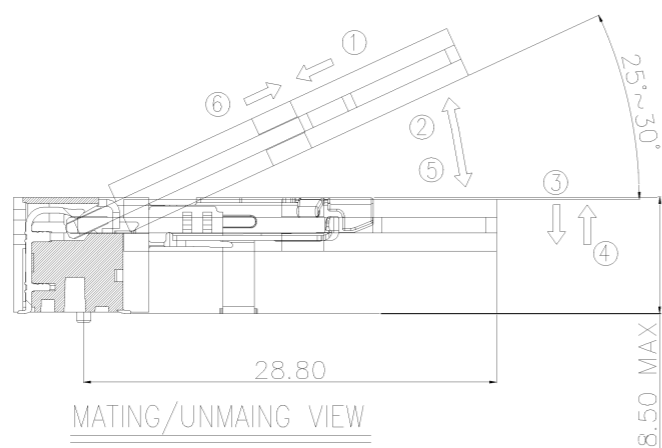
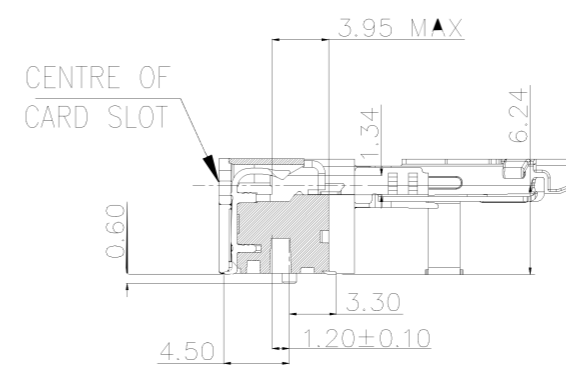
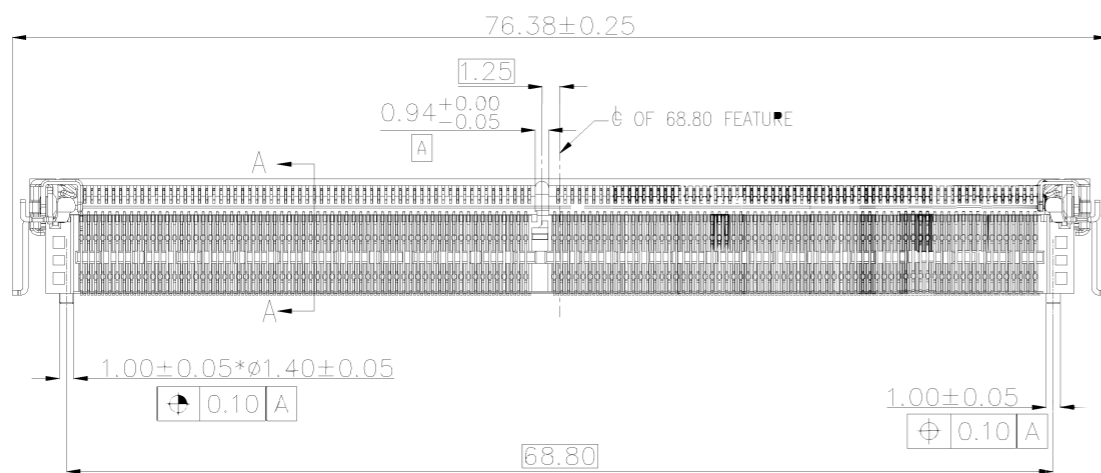

MATING:① INSETING(25)→② ROTATING →③ FIXED  
 UNMATING:④ INSETING(25)→⑤ ROTATING →⑥ WITH DRAWING

G	FIXED-B	1	SUS304 0.35T	Matt Tin plating All Over 120u"Min
F	FIXED-A	1	SUS304 0.35T	
E	LATCH-B	1	SUS304 0.35T	Clear
D	LATCH-A	1	SUS304 0.35T	
C	TERMINAL-B	131	C5210 0.15T	Contact area gold plating Solder TAIL G/F Ni 50u"Min Underplate
B	TERMINAL-A	131	C5210 0.15T	
A	HOUSING	1	LCP,UL94V-0	BLACK.
NO	DESCRIPTION	QTY	MATERIAL	PLATING & COLOR

GENERAL TOLERANCE	TOLERANCE	DWG.NO.	DDR006-S5401-**	PART.NO.	DDR006-S5401-**	DRAWN	DU 2023-06-06	UNIT	mm	SCALE	NO SCALE
x.±0.50	x.°± 5°	REV.	B	TITLE	DDR5 SO DIMM 262Pin(RVS) H8.0	CHECKED		 <b>东莞市欧联电子科技有限公司</b> DONGGUAN OLN ELECTRONICS TECHNOLOGY CO., LTD.			
.x±0.25	.x°± 2°	SIZE		SHEET	1 OF 4	APPROVED					
.xx±0.15	.xx°± 1°	A4									



RoHS Compliant HF

REV.	ECN.NO.	MODIFY.CONTENT
A		NEW
B	N23060601	CHANGE LATCH AND FIXED

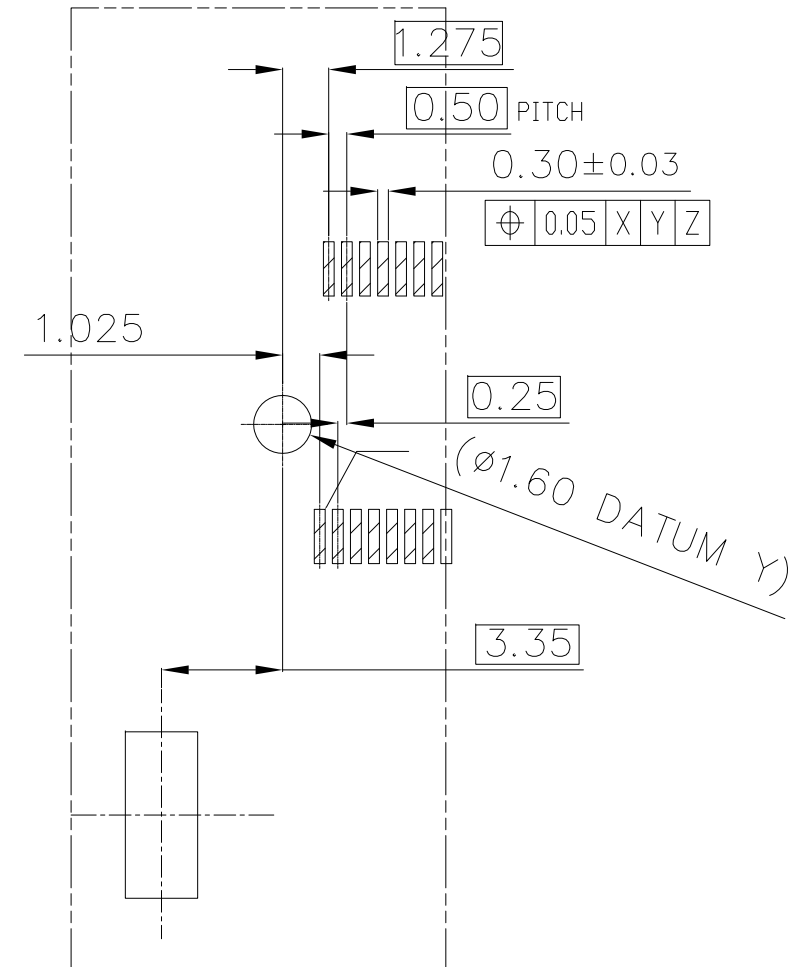
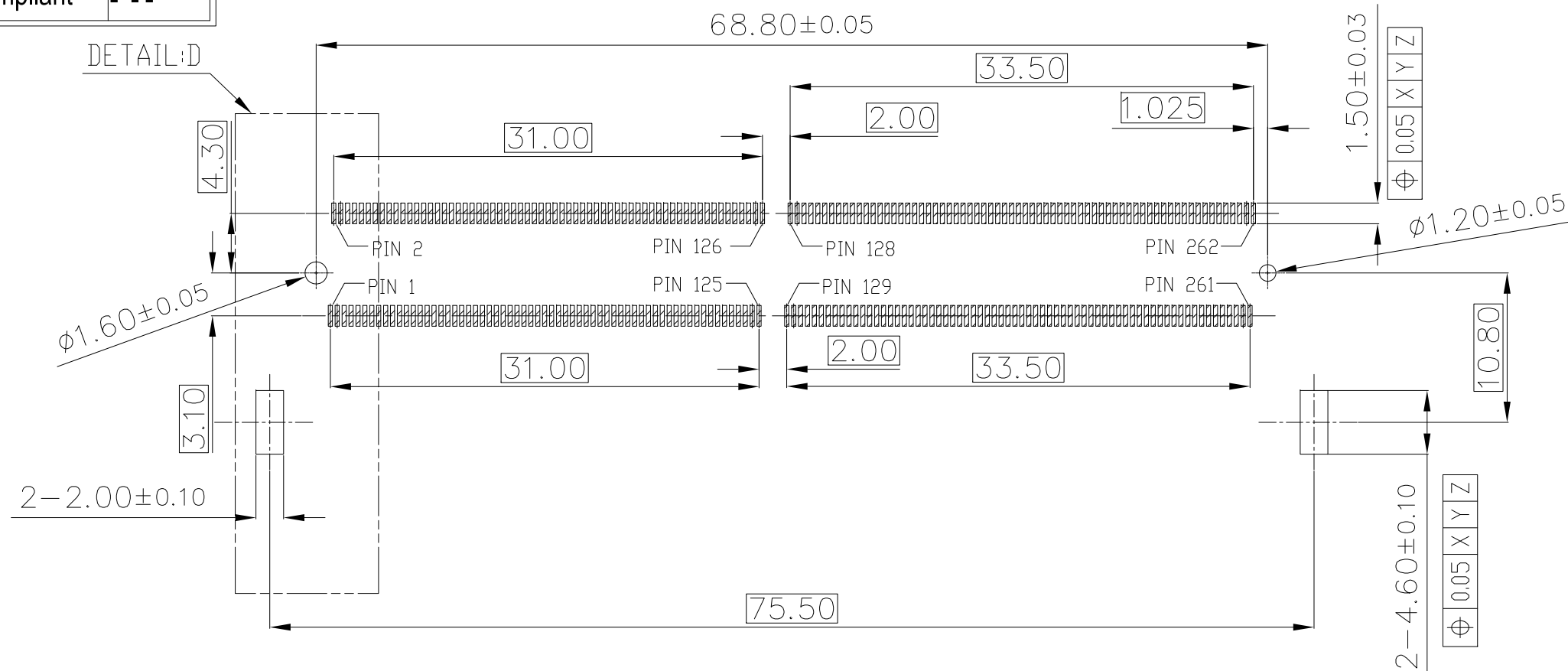

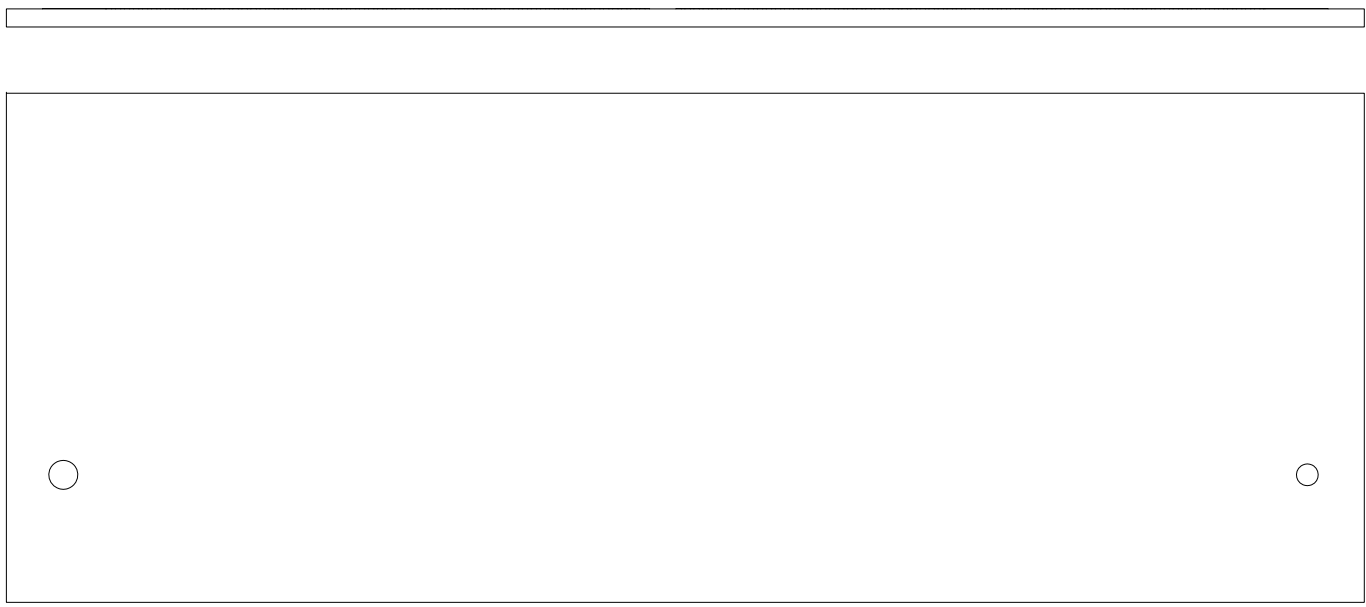

DETAIL:D  
SCALE 2:1

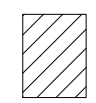

RECOMMEND PCB LAYOUT

THE TOLERANCE UNLESS SPECIFIED IS ±0.05 MM

 Solder pad area

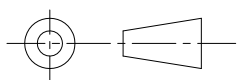
GENERAL TOLERANCE		DWG.NO.	DDR006-S5401-***	PART.NO.	DDR006-S5401-***	DRAWN	DU 2023-06-06	UNIT	mm	SCALE	NO SCALE
x.±0.50	x.°± 5°	REV.	B	TITLE	DDR5 SO DIMM 262Pin(RVS) H8.0	CHECKED		 东莞市欧联电子科技有限公司 DONGGUAN OLN ELECTRONICS TECHNOLOGY CO., LTD.			
.x±0.25	.x°± 2°	SIZE		SHEET	3 OF 4	APPROVED					
.xx±0.15	.xx°± 1°	A4									

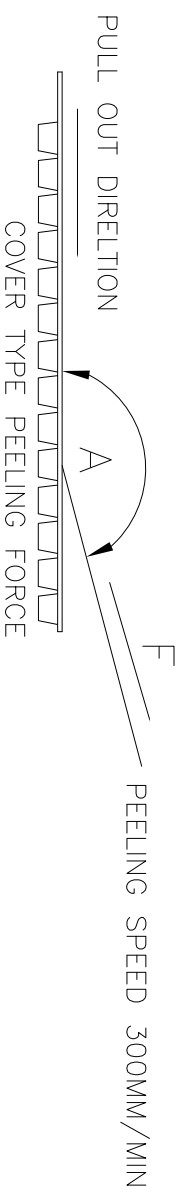
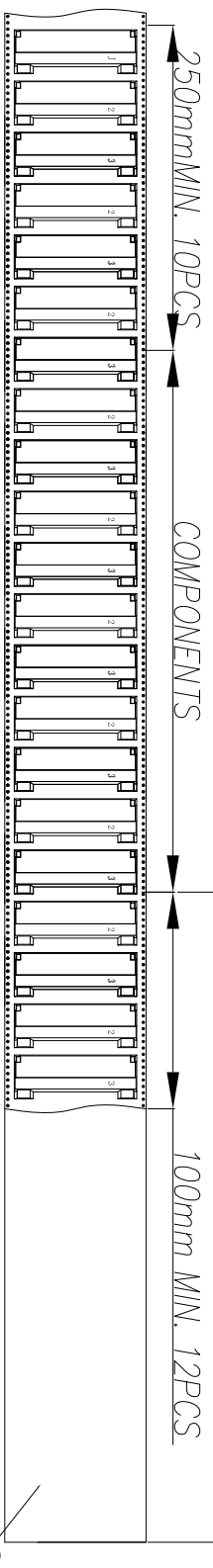
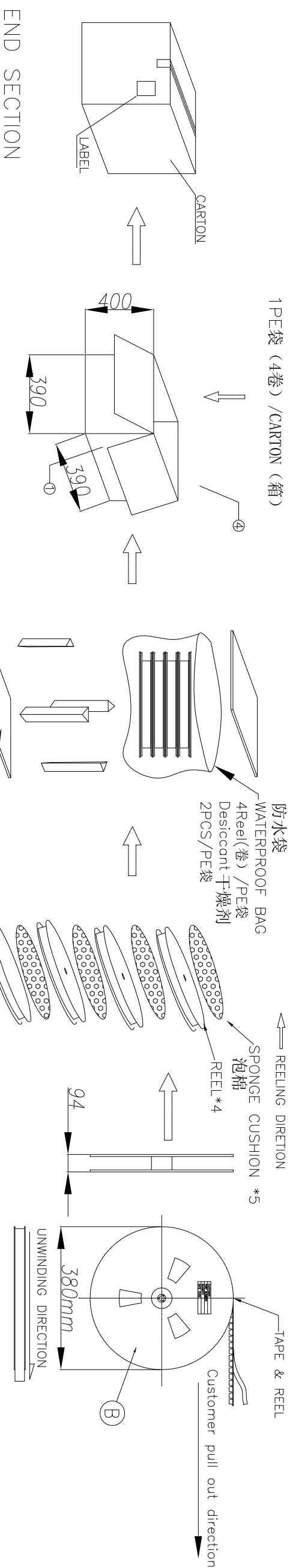
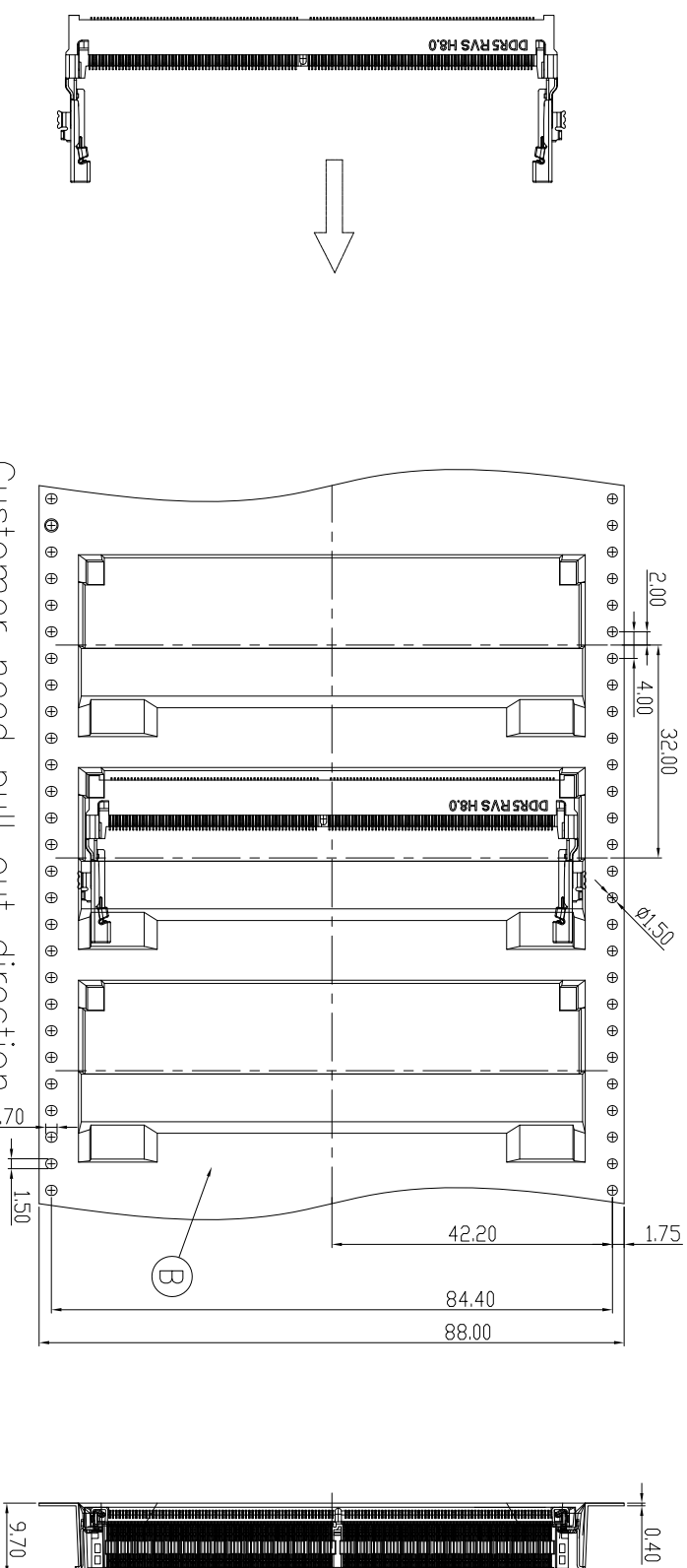

A	165°-180°
F	0.1N-1.3N

NOTES:

- 1.Quantity: 280PCS/Reel
- 2.Each plate needs vacuum packaging, and 2PCS desiccant is placed in the packaging bag

ITEM	MATERIAL	Q'TY	NOTE
⑤	WATERPROOF BAG	1	
④	SUPPORT BRACE	4	
③	REEL ASS'Y	4	
②	CARRIER TAPE	4	
①	CARTON	1	

GENERAL TOLERANCE DWG.NO. DDR006-SS401-\*\*

PART.NO. DDR006-SS401-\*\*

DRAWN DU 2023-06-06

UNIT mm SCALE ND SCALE

REV. X.±0.50 X.°± 5°

TITLE DDR5 SO DIMM 262Pin(RVS) H8.0

CHECKED

REV. .X.±0.25 .X.°± 2°

SHEET

4 DF 4

APPROVED

SIZE A4 .XX± 1°

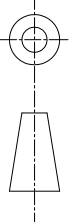

B

4 DF 4

APPROVED